



C Type

- Suitable for wet locations when used with gasketed covers.
- Federal Specification W-C-586D/A-A 50563.
- Suitable for use in hazardous location applications when installed according to NEC Articles 501.10(b), Class I, Div. 2, (Suitable for use in Class I Zone 2 applications) 502.10 and 503.10.

Listed File No. E3397

Certified File No. LR11852

FEATURES-SPECIFICATIONS

DURALOY® 8

Applications

To provide access to conductors for pulling, splicing, and maintenance. Threaded for rigid conduit and IMC.

Features

- Completely interchangeable with competitive bodies, gaskets, and covers
- Flat back design provides greater cubic capacity for easier wire pulling and more room for splicing
- Raintight when used with gasketed covers
- Stainless steel screws on stamped and cast covers
- Smooth integral wire bushings

Material/Finish

Duraloy Class 30 Gray Iron Alloy

- Tri-coat finish of electrozinc, chromate sealant, and electrostatically applied powder coating.

C TYPE CONDUIT BODY*									
CATALOG NUMBER	HUB SIZE	DIMENSIONS							VOLUME CU. IN.
		A	B	C	D	E	F	G	
C18	1/2"	5-5/16" (135)	1-15/32" (37)	1-15/32" (37)	1" (25)	3-9/32" (83)	—	5/8" (16)	5.0
C28	3/4"	6-9/16" (167)	1-11/16" (43)	1-21/32" (42)	1-3/16" (30)	3-15/16" (100)	—	3/4" (19)	8.0
C38	1"	7-9/16" (192)	1-31/32" (50)	1-27/32" (47)	1-3/8" (35)	4-17/32" (115)	—	7/8" (22)	12.25
C448	1-1/4"	8-7/16" (214)	2-3/8" (60)	2-5/32" (55)	1-3/4" (44)	5-15/16" (151)	—	1-3/32" (28)	23.25
C58	1-1/2"	10-3/8" (264)	2-25/32" (71)	2-25/32" (71)	2-3/32" (53)	6-1/2" (165)	—	1-3/8" (35)	42.50
C68	2"	12-3/8" (314)	3-9/16" (90)	3-27/32" (98)	3" (76)	8-5/8" (219)	—	1-7/8" (48)	105.00
C78	2-1/2"	15-5/8" (397)	4-7/16" (113)	5" (127)	4-1/4" (108)	10-7/8" (276)	—	2-1/2" (64)	200.00
C88	3"	15-5/8" (397)	4-13/16" (122)	5" (127)	4-1/4" (108)	10-7/8" (276)	—	2-1/2" (64)	217.00

* For conduit body packaged with cover and gasket, add **CG** to the catalog number.

Dimensions

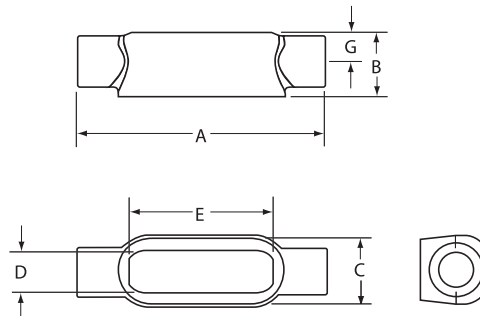

C Type

F



LB Type



LL Type

- Suitable for wet locations when used with gasketed covers.
- Federal Specification W-C-586D/A-A 50563.
- Suitable for use in hazardous location applications when installed according to NEC Articles 501.10(b), Class I, Div. 2, (Suitable for use in Class I Zone 2 applications) 502.10 and 503.10.

 Listed File No. E3397

 Certified File No. LR11852

FEATURES-SPECIFICATIONS

DURALOY® 8

See page F11 for Standard Materials & Finish

Dimensions

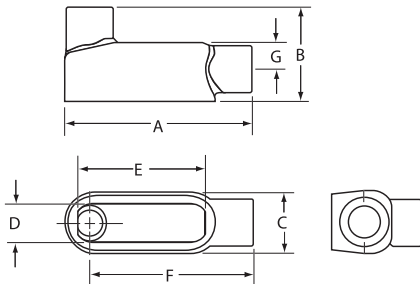

LB Type

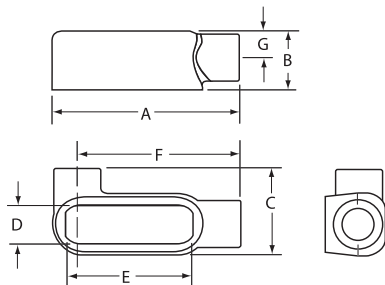

LL Type

LB TYPE CONDUIT BODY*									
CATALOG NUMBER	HUB SIZE	DIMENSIONS							VOLUME CU. IN.
		A	B	C	D	E	F	G	
LB18	1/2"	5-3/32" (129)	2-9/32" (58)	1-15/32" (37)	1" (25)	3-9/32" (83)	4-3/8" (111)	5/8" (16)	5.0
LB28	3/4"	5-3/4" (146)	2-1/2" (64)	1-21/32" (42)	1-3/16" (30)	3-15/16" (100)	4-29/32" (125)	3/4" (19)	8.0
LB38	1"	6-5/8" (168)	2-29/32" (74)	1-27/32" (47)	1-3/8" (35)	4-17/32" (115)	5-23/32" (145)	7/8" (22)	13.0
LB448	1-1/4"	7-1/2" (191)	3-5/16" (84)	2-5/32" (55)	1-3/4" (44)	5-15/16" (151)	6-13/32" (163)	1-3/32" (28)	24.0
LB58	1-1/2"	9-1/8" (232)	4-1/32" (102)	4-25/32" (121)	2-3/32" (53)	6-1/2" (165)	7-3/4" (197)	1-3/8" (35)	42.0
LB68	2"	11-1/8" (283)	4-13/16" (122)	4-13/16" (122)	3" (76)	8-5/8" (219)	9-3/16" (233)	1-7/8" (48)	105.0
LB78	2-1/2"	13-15/16" (354)	6-1/8" (156)	6-1/8" (156)	4-1/4" (108)	10-7/8" (276)	11-7/16" (291)	2-1/2" (64)	200.0
LB888	3"	13-15/16" (354)	6-1/2" (165)	6-1/2" (165)	4-1/4" (108)	10-7/8" (276)	11-7/16" (291)	2-1/2" (64)	217.0
LB98	3-1/2"	16-7/8" (429)	7-9/16" (192)	7-9/16" (192)	5-7/16" (138)	13-7/8" (352)	13-3/4" (349)	3-1/8" (79)	380.0
LB108	4"	16-7/8" (429)	7-13/16" (198)	7-13/16" (198)	5-7/16" (138)	13-7/8" (352)	13-3/4" (349)	3-1/8" (79)	400.0

LL TYPE CONDUIT BODY*									
CATALOG NUMBER	HUB SIZE	DIMENSIONS							VOLUME CU. IN.
		A	B	C	D	E	F	G	
LL18	1/2"	5-3/32" (129)	2-9/32" (56)	1-15/32" (37)	1" (25)	3-9/32" (83)	4-3/8" (111)	5/8" (16)	5.0
LL28	3/4"	5-3/4" (146)	2-1/2" (64)	1-21/32" (42)	1-3/16" (30)	3-15/16" (100)	4-29/32" (125)	3/4" (19)	8.0
LL38	1"	6-5/8" (168)	2-29/32" (74)	1-27/32" (47)	1-3/8" (35)	4-17/32" (115)	5-23/32" (145)	7/8" (22)	13.0
LL448	1-1/4"	7-1/2" (191)	3-5/16" (84)	2-5/32" (55)	1-3/4" (44)	5-15/16" (151)	6-13/32" (163)	1-3/32" (28)	24.0
LL58	1-1/2"	9-1/8" (232)	4-1/32" (102)	4-25/32" (121)	2-3/32" (53)	6-1/2" (165)	7-3/4" (197)	1-3/8" (35)	42.0
LL68	2"	11-1/8" (283)	4-13/16" (122)	4-13/16" (122)	3" (76)	8-5/8" (219)	9-3/16" (233)	1-7/8" (48)	105.0
LL78	2-1/2"	13-15/16" (354)	6-1/8" (156)	6-1/8" (156)	4-1/4" (108)	10-7/8" (276)	11-7/16" (291)	2-1/2" (64)	200.0
LL888	3"	13-15/16" (354)	6-1/2" (165)	6-1/2" (165)	4-1/4" (108)	10-7/8" (276)	11-7/16" (291)	2-1/2" (64)	217.0

* For conduit body packaged with cover and gasket, add **CG** to the catalog number.



KILLARK®



LR Type



T Type

- Suitable for wet locations when used with gasketed covers.
- Federal Specification W-C-586D/A-A 50563.
- Suitable for use in hazardous location applications when installed according to NEC Articles 501.10(b), Class I, Div. 2, (Suitable for use in Class I Zone 2 applications) 502.10 and 503.10.

Listed File No. E3397

Certified File No. LR11852

FEATURES-SPECIFICATIONS



See page F11 for Standard Materials & Finish

Dimensions

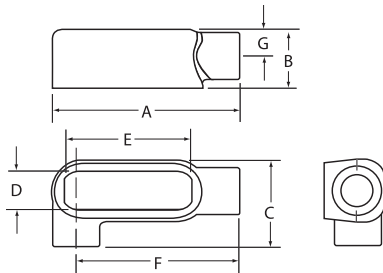

LR Type

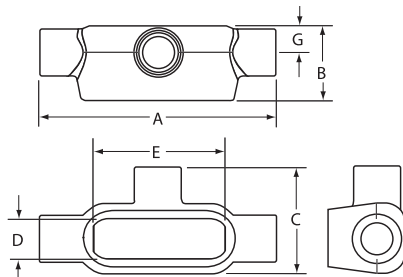

T Type

LR TYPE CONDUIT BODY*									
CATALOG NUMBER	HUB SIZE	DIMENSIONS							VOLUME CU. IN.
		A	B	C	D	E	F	G	
LR18	1/2"	5-3/32" (129)	1-15/16" (49)	2-9/32" (58)	1" (52)	3-9/32" (83)	4-3/8" (111)	5/8" (16)	5.0
LR28	3/4"	5-3/4" (146)	1-11/16" (43)	2-1/2" (64)	1-3/16" (30)	3-15/16" (84)	4-29/32" (125)	3/4" (19)	8.0
LR38	1"	6-5/8" (168)	1-31/32" (50)	2-29/32" (74)	1-3/8" (35)	4-17/32" (115)	5-23/32" (145)	7/8" (22)	13.0
LR448	1-1/4"	7-1/2" (191)	2-3/8" (60)	3-5/16" (84)	1-3/4" (44)	5-15/16" (151)	6-13/32" (163)	1-3/32" (28)	24.0
LR58	1-1/2"	9-1/8" (232)	2-25/32" (71)	4-1/32" (102)	2-3/32" (53)	6-1/2" (165)	7-3/4" (199)	1-3/8" (35)	42.0
LR68	2"	11-1/8" (283)	3-9/16" (90)	4-13/16" (122)	3" (76)	8-5/8" (219)	9-3/16" (233)	1-7/8" (48)	105.0
LR78	2-1/2"	13-15/16" (354)	4-7/16" (113)	6-1/8" (156)	4-1/4" (108)	10-7/8" (276)	11-7/16" (291)	2-1/2" (64)	200.0
LR888	3"	13-15/16" (354)	4-13/16" (122)	6-1/2" (165)	4-1/4" (108)	10-7/8" (276)	11-7/16" (291)	2-1/2" (64)	217.0

T TYPE CONDUIT BODY*									
CATALOG NUMBER	HUB SIZE	DIMENSIONS							VOLUME CU. IN.
		A	B	C	D	E	F	G	
T18	1/2"	5-15/16" (151)	1-25/32" (45)	2-5/16" (59)	1" (25)	3-9/32" (83)	—	5/8" (16)	6.0
T28	3/4"	6-9/16" (167)	2" (51)	2-1/2" (64)	1-3/16" (30)	3-15/16" (100)	—	3/4" (19)	10.0
T38	1"	7-9/16" (192)	2-9/32" (58)	2-25/32" (71)	1-3/8" (35)	4-17/32" (115)	—	7/8" (22)	15.0
T448	1-1/4"	8-7/16" (214)	2-5/8" (67)	3-1/8" (79)	1-3/4" (44)	5-5/16" (135)	—	1-3/32" (28)	25.0
T58	1-1/2"	10-3/8" (264)	2-25/32" (71)	4-1/32" (102)	2-3/32" (53)	6-1/2" (165)	—	1-3/8" (35)	44.0
T68	2"	12-3/8" (314)	3-9/16" (90)	5-1/8" (130)	3" (76)	8-5/8" (219)	—	1-7/8" (48)	105.0
T78	2-1/2"	15-5/8" (397)	4-7/16" (113)	6-11/16" (170)	4-1/4" (108)	10-11/16" (271)	—	2-1/2" (64)	200.0
T88	3"	15-5/8" (397)	4-13/16" (122)	6-11/16" (170)	4-1/4" (108)	10-11/16" (271)	—	2-1/2" (64)	217.0

* For conduit body packaged with cover and gasket, add **CG** to the catalog number.



TB Type



X Type

- Suitable for wet locations when used with gasketed covers.
- Federal Specification W-C-586D/A-A 50563.
- Suitable for use in hazardous location applications when installed according to NEC Articles 501.10(b), Class I, Div. 2, (Suitable for use in Class I Zone 2 applications) 502.10 and 503.10.

Listed File No. E3397

Certified File No. LR11852

FEATURES-SPECIFICATIONS

DURALOY® 8

See page F11 for Standard Materials & Finish

Dimensions

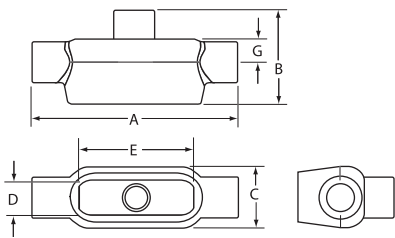

TB Type

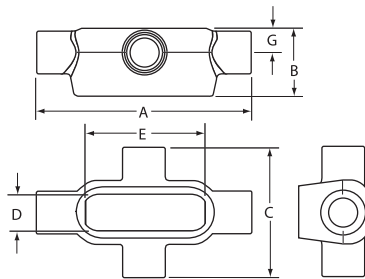

X Type

TB TYPE CONDUIT BODY*									
CATALOG NUMBER	HUB SIZE	DIMENSIONS							VOLUME CU. IN.
		A	B	C	D	E	F	G	
TB18	1/2"	5-15/16" (151)	2-15/16" (75)	1-15/16" (49)	1" (25)	3-9/32" (83)	—	5/8" (16)	6.0
TB28	3/4"	6-9/16" (167)	2-1/2" (64)	1-21/32" (42)	1-3/16" (30)	3-15/16" (100)	—	3/4" (19)	10.0
TB38	1"	7-9/16" (192)	2-25/32" (71)	1-27/32" (47)	1-3/8" (35)	4-17/32" (115)	—	7/8" (22)	15.0
TB448	1-1/4"	8-7/16" (214)	3-1/8" (79)	2-3/16" (55)	1-3/4" (44)	5-5/16" (135)	—	1-3/32" (26)	25.0
TB58	1-1/2"	10-3/8" (264)	4-1/32" (102)	2-25/32" (71)	2-3/32" (53)	6-1/2" (165)	—	1-3/8" (35)	44.0
TB68	2"	12-3/8" (314)	5-1/8" (130)	3-7/8" (98)	3" (76)	8-5/8" (219)	—	1-7/8" (48)	105.0

X TYPE CONDUIT BODY*									
CATALOG NUMBER	HUB SIZE	DIMENSIONS							VOLUME CU. IN.
		A	B	C	D	E	F	G	
X18	1/2"	5-15/16" (151)	1-25/32" (45)	3-1/8" (79)	1" (25)	3-9/32" (83)	—	5/8" (16)	6.0
X28	3/4"	6-9/16" (167)	2" (51)	3-15/16" (100)	1-3/16" (30)	3-15/16" (100)	—	3/4" (19)	10.0
X38	1"	7-9/16" (192)	2-9/32" (58)	3-23/32" (94)	1-3/8" (35)	4-17/32" (115)	—	7/8" (22)	15.0
X448	1-1/4"	8-7/16" (214)	2-5/8" (67)	4-1/16" (103)	1-3/4" (44)	5-5/16" (135)	—	1-3/32" (26)	25.0
X58	1-1/2"	10-3/8" (264)	2-25/32" (71)	5-9/32" (134)	2-3/32" (53)	6-1/2" (165)	—	1-3/8" (35)	44.0
X68	2"	12-3/8" (314)	3-9/16" (90)	6-3/8" (162)	3" (76)	8-5/8" (219)	—	1-7/8" (48)	105.0

* For conduit body packaged with cover and gasket, add **CG** to the catalog number.



KILLARK®



Cast Covers

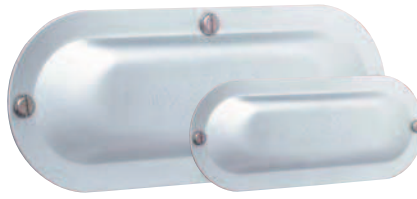

Stamped Steel Covers

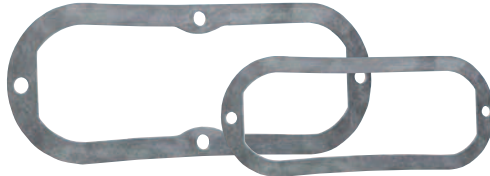

Cover Gaskets (Neoprene)

- Suitable for wet locations when used with gasketed covers.
- Federal Specification W-C-586D/A-A 50563.
- Suitable for use in hazardous location applications when installed according to NEC Articles 501.10(b), Class I, Div. 2, (Suitable for use in Class I Zone 2 applications) 502.10 and 503.10.

Listed File No. E3397

Certified File No. LR11852

FEATURES-SPECIFICATIONS

DURALOY® 8

See page F11 for Standard Materials & Finish

Cast Material/Finish

Duraloy Class 30 Gray Iron Alloy

- Tri-coat finish of electrozinc, chromate sealant, and electrostatically applied powder coating
- 300 Series stainless steel screws

Galvanized Steel

- Natural finish
- 300 Series stainless steel screws

Material/Finish

- Neoprene. Compression molded.

CAST IRON COVERS				
CATALOG NUMBER	HUB SIZE	OVERALL DIMENSIONS		
		LENGTH	WIDTH	HEIGHT
180F	1/2"	4-7/32"(107)	1-15/32"(37)	3/8"(10)
280F	3/4"	4-13/16"(122)	1-21/32"(42)	3/8"(10)
380F	1"	5-19/32"(142)	1-27/32"(47)	5/8"(16)
480F	1-1/4"	6-9/16"(167)	2-3/16"(56)	5/8"(16)
580F	1-1/2"	7-7/8"(200)	2-25/32"(71)	5/8"(16)
680F	2"	9-3/4"(248)	3-7/8"(98)	5/8"(16)
880F	2-1/2"	12-1/4"(311)	5"(127)	5/8"(16)
880F	3"	12-1/4"(311)	5"(127)	5/8"(16)
980F	3-1/2"	15"(381)	6-1/4"(159)	5/8"(16)
980F	4"	15"(381)	6-1/4"(159)	5/8"(16)

STAMPED STEEL COVERS				
CATALOG NUMBER	HUB SIZE	OVERALL DIMENSIONS		
		LENGTH	WIDTH	HEIGHT
180S	1/2"	4-7/32"(107)	1-15/32"(37)	5/16"(8)
280S	3/4"	4-13/16"(122)	1-21/32"(42)	5/16"(8)
380S	1"	5-19/32"(142)	1-27/32"(47)	5/16"(8)
480S	1-1/4"	6-9/16"(167)	2-3/16"(56)	5/16"(8)
580S	1-1/2"	7-7/8"(200)	2-25/32"(71)	5/16"(8)
680S	2"	9-3/4"(248)	3-7/8"(98)	5/16"(8)
880S	2-1/2"	12-1/4"(311)	5"(127)	9/16"(14)
880S	3"	12-1/4"(311)	5"(127)	9/16"(14)
980S	3-1/2"	15"(381)	6-1/4"(159)	9/16"(14)
980S	4"	15"(381)	6-1/4"(159)	9/16"(14)

COVER GASKETS				
CATALOG NUMBER	HUB SIZE	OVERALL DIMENSIONS		
		LENGTH	WIDTH	HEIGHT
GASK851N	1/2"	4-7/32"(107)	1-15/32"(37)	1/8"(3)
GASK852N	3/4"	4-13/16"(122)	1-21/32"(42)	1/8"(3)
GASK853N	1"	5-19/32"(142)	1-27/32"(47)	1/8"(3)
GASK854N	1-1/4"	6-9/16"(167)	2-3/16"(56)	1/8"(3)
GASK805N	1-1/2"	7-7/8"(200)	2-25/32"(71)	1/8"(3)
GASK806N	2"	9-3/4"(248)	3-7/8"(98)	1/8"(3)
GASK808N	2-1/2"	12-1/4"(311)	5"(127)	1/8"(3)
GASK808N	3"	12-1/4"(311)	5"(127)	1/8"(3)
GASK809N	3-1/2"	15"(381)	6-1/4"(159)	1/8"(3)
GASK809N	4"	15"(381)	6-1/4"(159)	1/8"(3)