

Hubbell Premise Wiring's new NEXTFRAME Ladder Rack is the effective and widely used cable runway that supports and delivers bundles of cable between cabinets, racks, and closets, along walls, and suspended from ceilings.

The Ladder Rack System features light, rugged, tubular steel construction. It is designed for mechanical support and strain relief in long runs of cable and creates a smooth gradual bend for cable. Rail and stringer material is 16 ga steel tubing.

The NEXTFRAME Ladder Rack is available in popular gray and black finishes to complement equipment in any data center. The complete NEXTFRAME Ladder Rack system features a broad line of sizes and fittings required for proper installation.

SPECIFICATIONS

- Material: 16 ga tubular steel
- Finish: Durable black or gray powder coat
- Stringer Dimensions: 0.375"W x 1.5"H

FEATURES

- Lightweight, strong 16ga tubular steel construction
- Supports horizontal/vertical and overhead cable management
- Durable black or gray powder coat finish
- Modular system - easily configured for new and existing cable routing
- Supports UTP or fiber cabling
- Mounts to floors, walls, ceilings, equipment racks, and cabinets
- Complete family of accessories includes: wall supports and brackets, cable drops, retaining posts, splice kits, and ceiling mounting kits



Ladder Rack - Straight Lengths

Use Ladder Rack to run and support cable between racks, along walls, and suspended from ceiling. Provides mechanical support and strain relief for long runs of cable. Creates a smooth, gradual bend for cable. Rail and stringer material is 16 ga steel tubing.

Width	Cat. No. - Black 6' (1829) Length	Cat. No. - Gray 6' (1829) Length	Cat. No. - Black 10' (3048) Length	Cat. No. - Gray 10' (3048) Length
6" (152)	HLS0606B	HLS0606G	HLS1006B	HLS1006G
12" (305)	HLS0612B	HLS0612G	HLS1012B	HLS1012G
18" (457)	HLS0618B	HLS0618G	HLS1018B	HLS1018G
24" (610)	HLS0624B	HLS0624G	HLS1024B	HLS1024G

Please order in multiples of 10.

Dimensions

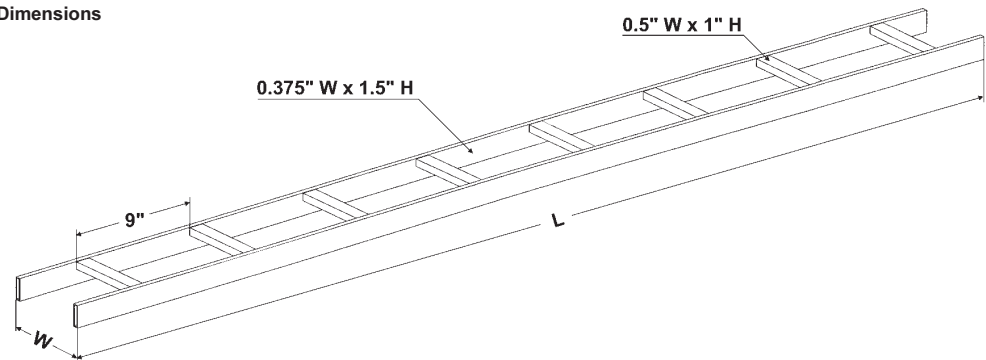

Dimensions

Inside
Radius 90°

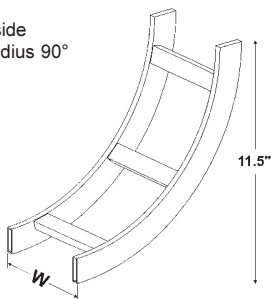

Flat Turn
90°

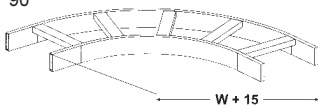

Outside
Radius 90°

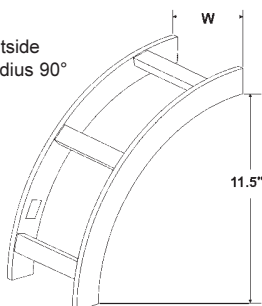

Ladder Rack - 90° Inside/Outside Radius, Flat Turns

Use to create a gradual, smooth bend for cable. Provides mechanical support and strain relief when making turns with cable. Rail and stringer material is 16 ga steel tubing.



Inside Radius 90°

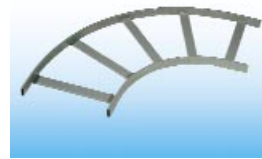

Flat Turns 90°



Outside Radius 90°

Width	Cat. No. Black	Cat. No. Black	Cat. No. Black
6" (152)	HLI0690B	HLF0690B	HLO0690B
12" (305)	HLI1290B	HLF1290B	HLO1290B
18" (457)	HLI1890B	HLF1890B	HLO1890B
24" (610)	HLI2490B	HLF2490B	HLO2490B
	Cat. No. Gray	Cat. No. Gray	Cat. No. Gray
6" (152)	HLI0690G	HLF0690G	HLO0690G
12" (305)	HLI1290G	HLF1290G	HLO1290G
18" (457)	HLI1890G	HLF1890G	HLO1890G
24" (610)	HLI2490G	HLF2490G	HLO2490G

ORDERING INFORMATION-ACCESSORIES

Mounting Kit to Relay Rack

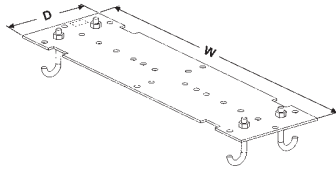
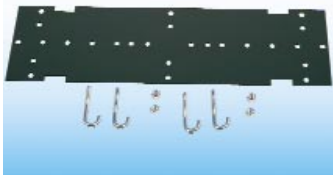

Use to secure ladder rack to top of 19" or 23" equipment rack.

Delivery Includes: 1 mounting plate, 4 J-bolts, 4 hex nuts

Color	Width	Depth	Catalog No.
Black	19" (483)	5.38" (137)	HLMPK19B

Triangle Wall Support

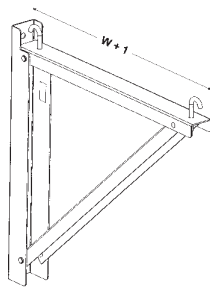

Use to run ladder rack along wall

Delivery Includes: 1 triangle wall support, 2 J-bolts, 2 hex nuts with lock washer

Width	Catalog No. Black	Catalog No. Gray
6" (152)	HLTSB06B	HLTSB06G
12" (305)	HLTSB12B	HLTSB12G
18" (457)	HLTSB18B	HLTSB18G
24" (610)	HLTSB24B	HLTSB24G

Wall Angle Support

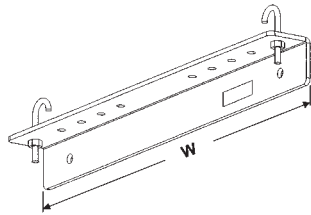

Material = 2" x 2" x 3/16"

Use to terminate ladder rack to wall.

Delivery Includes: 1 wall angle support, 2 J-bolts, 2 hex nuts with lock washer

Ladder Width	Width	Catalog No. Gray
6-12" (152-305)	14"	HLX0612
18" (457)	20"	HLX1518
24" (610)	26"	HLX24

Cable Radius Drop

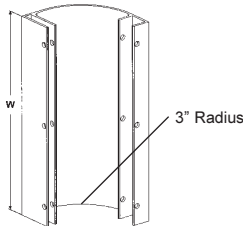

Assembled to stringers or rungs to provide gradual transition for cable

Delivery Includes: 1 cable radius drop, 6 screws, 3 hex nuts

Width	Catalog No. Gray
6" (152)	HLCD06
12" (305)	HLCD12
18" (457)	HLCD18
Stringer 7.5" (191)	HLCD5

Cable Retaining Post

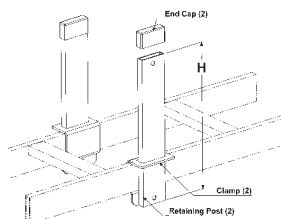

Use along ladder stringers to maximize cable routing and management

Delivery Includes: 1 cable retaining post, 1 bracket, 1 end cap, 2 screws and 2 washers

Height	Catalog No. Black	Catalog No. Gray
6" (152)	HLP06B	HLP06G
8" (203)	HLP08B	HLP08G
10" (254)	HLP10B	HLP10G

ORDERING INFORMATION - ACCESSORIES

Butt-Splice Kit



Use to splice two sections of ladder end to end
 Delivery Includes: 4 splice clamps, 2 bolts, 2 hex nuts, 2 lock washers
 Catalog No. **HLBSK**

Foot Kit



Use to secure vertical ladder to floor
 Delivery Includes: 2 foot angles, 4 splice plates, 2 bolts, 2 hex nuts, 2 split lock washers
 Catalog No. **HLRF**

T-Junction Splice Kit



Use to connect one section of ladder perpendicular to another
 Delivery Includes: 4 T-junctions, 2 carriage bolts, 2 hex nuts, 2 split lock washers
 Catalog No. **HLTK**

Vertical Wall Bracket



Use to secure ladder rack vertically to wall
 Delivery: 2 vertical wall brackets
 Catalog No. **HLVWBK**

Ceiling Mounting Kit



Use to hang ladder from ceiling
 Delivery Includes: 2 ceiling support brackets, 2 U-brackets, 6 threaded rod, 8 nuts
 Catalog No. **HLCKMK**
 (Includes 5/8" threaded rod)

Protective End Caps



Use to dress ends of stringers and cable posts
 Delivery Includes: 2 end caps
 Catalog No. **HLEC**

J-Bolt Kit



Use to secure ladder to brackets
 Delivery Includes: 2 J-bolts, 2 hex nuts with lock washer
 Catalog No. **HLJB**

RELATED PRODUCTS

Call Hubbell Premise Wiring today at 1-800-626-0005 to receive more information about our family of products:

Series	Description
HC	NEXTFRAME Horizontal Cable Management Panels and Accessories
CR	NEXTFRAME Vertical Cable Management
VC	Organizers and Racks
HPWCVF	Velcro® One-Wrap Cable Ties



Hubbell Premise Wiring
 HUBBELL INCORPORATED (Delaware)
 14 Lord's Hill Road • Stonington, CT 06378-0901 • (860) 535-8326 • 800-626-0005
 Fax: (860) 535-8328 • Internet site: <http://www.hubbell-premise.com>

Worldwide Locations

Hubbell Premise Wiring, Asia Pacific	852-2836-7131	Fax: 852-2836-7132	Hubbell de Mexico, S.A. de C.V.	52-5-575-2022	Fax: 52-5-559-8626
Hubbell Canada Inc.	905-839-1138	Fax: 905-839-9108	Hubbell Premise Wiring, Middle East	971-4-393-4192	Fax: 971-4-393-4194
Hubbell Premise Wiring, China	86-21-6217-3478	Fax: 86-21-6217-3481	Hubbell Premise Wiring, Puerto Rico	787-460-3380	Fax: 787-751-7309
Hubbell Premise Wiring, Europe	44-(0)1234-848550	Fax: 44-(0)1234-856190	Hubbell-Taian Co., Ltd., Taiwan	886-2-(0)2515-0855	Fax: 886-2-(0)2515-0899
Hubbell Int'l. Inc., Korea Branch	82-2-(0)2607-1363	Fax: 82-2-(0)2603-7386	Hubbell Incorporated, Turkey	90-216-414-8147	Fax: 90-216-414-8148
Hubbell Premise Wiring, Latin America	305-251-4236	Fax: 305-251-4087	Hubbell Premise Wiring, Venezuela	58-81-820323	Fax: 58-81-820323

DS-M15 4/00